

E6H-C

Hollow-shaft Encoder



- Incremental model.
- External diameter of 40 mm.
- Resolution of up to 3,600 ppr.
- Slim design at only 26 mm thick.



For the most recent information on models that have been certified for safety standards, refer to your OMRON website.

 Be sure to read *Safety Precautions* on page 4.

Ordering Information

Encoders [\[Refer to Dimensions on page 4.\]](#)

Power supply voltage	Output configuration	Resolution (pulses/rotation)	Model
5 to 24 VDC	Open-collector output	300, 360, 500, 600, 720, 800, 1,000, 1,024	E6H-CWZ6C (resolution) 0.5M Example: E6H-CWZ6C 300P/R 0.5M
		1,200, 1,500, 1,800, 2,000, 2,048	
		2,500, 3,600	
5 to 12 VDC	Voltage output	300, 360, 500, 600, 720, 800, 1,000, 1,024	E6H-CWZ3E (resolution) 0.5M Example: E6H-CWZ3E 300P/R 0.5M
		1,200, 1,500, 1,800, 2,000, 2,048	
		2,500, 3,600	
5 to 12 VDC	Line-driver output	300, 360, 500, 600, 720, 800, 1,000, 1,024	E6H-CWZ3X (resolution) 0.5M Example: E6H-CWZ3X 300P/R 0.5M
		1,200, 1,500, 1,800, 2,000, 2,048	
		2,500, 3,600	

Ratings and Specifications

Item	Model	E6H-CWZ6C	E6H-CWZ3E	E6H-CWZ3X
Power supply voltage		5 VDC -5% to 24 VDC +15%, ripple (p-p): 5% max.	5 VDC -5% to 12 VDC +10%, ripple (p-p): 5% max.	
Current consumption*1		100 mA max.		150 mA max.
Resolution (pulses/rotation)		300, 360, 500, 600, 720, 800, 1,000, 1,024, 1,200, 1,500, 1,800, 2,000, 2,048, 2,500, 3,600		
Output phases		Phases A, B, and Z		Phases A, \bar{A} , B, \bar{B} , Z, and \bar{Z}
Output configuration		Open-collector output	Voltage output	Line-driver output*4
Output capacity		Applied voltage: 35 VDC max. Sink current: 35 mA max. Residual voltage: 0.7 V max. (at sink current of 35 mA)	Output resistance: 1 k Ω Sink current: 30 mA max. Residual voltage: 0.7 V max. (at sink current of 30 mA)	Output current: High level: $I_o = -10$ mA Low level: $I_s = 10$ mA Output voltage: $V_o = 2.5$ V min. $V_s = 0.5$ V
Maximum response frequency*2		100 kHz		
Phase difference between outputs		$90^\circ \pm 45^\circ$ between A and B ($1/4$ T \pm $1/8$ T)		
Rise and fall times of output		1 μ s max. (Control output voltage: 5 V, Load resistance: 1 k Ω , Output cable: 500 mm)	1 μ s max. ($I_o = -10$ mA, $I_s = 10$ mA, Output cable: 500 mm)	
Starting torque		1.5 mN·m max.		
Moment of inertia		2×10^{-6} kg·m ² max.		
Shaft loading	Radial	29.4 N		
	Thrust	4.9 N		
Maximum permissible speed		10,000 r/min		
Ambient temperature range		Operating: -10 to 70°C (at 90% humidity max.), Storage: -30 to 85°C (with no icing)		
Ambient humidity range		Operating/Storage: 95% max. (with no condensation)		
Insulation resistance		Excluded because of capacitor ground.		
Dielectric strength		Excluded because of capacitor ground.		
Vibration resistance		Destruction: 10 to 500 Hz, 100 m/s ² or 1.5-mm double amplitude for 2 hours each in X, Y, and Z directions		
Shock resistance		300 m/s ² for 11 ms 3 times each in X, Y, and Z directions (excluding shock to the shaft)		
Degree of protection*3		IEC 60529 IP50		
Connection method		Pre-wired Models (Standard cable length: 0.5 m)		
Material		Case: Iron, Main unit: Aluminum, Pressboard panel: SUS304		
Weight (packed state)		Approx. 120 g		
Accessories		Instruction manual		

*1. An inrush current of approximately 6 A will flow for approximately 0.3 ms when the power is turned ON.

*2. The maximum electrical response speed is determined by the resolution and maximum response frequency as follows:

$$\text{Maximum electrical response speed (rpm)} = \frac{\text{Maximum response frequency}}{\text{Resolution}} \times 60$$

This means that the Rotary Encoder will not operate electrically if its speed exceeds the maximum electrical response speed.

*3. No protection is provided against water or oil.

*4. The line driver output is a data transmission circuit compatible with RS-422A and long-distance transmission is possible with a twisted-pair cable. The quality is equivalent to AM26LS31.

I/O Circuit Diagrams

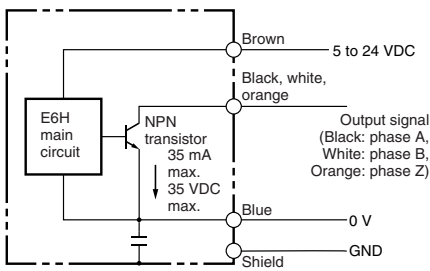
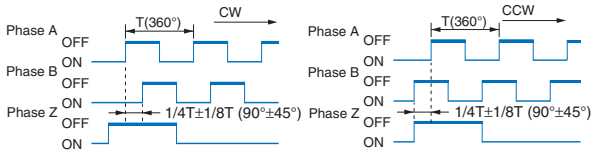
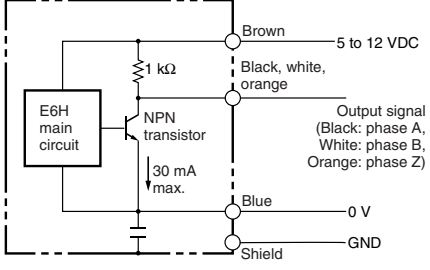
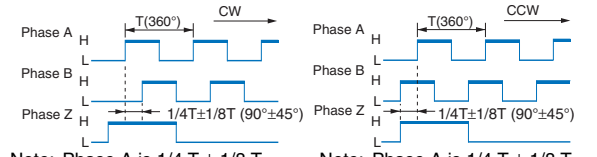
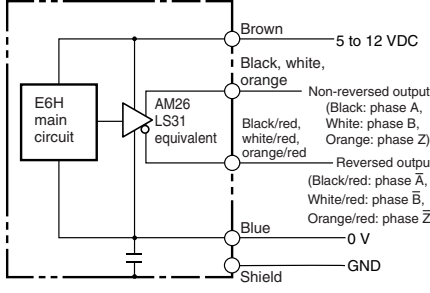
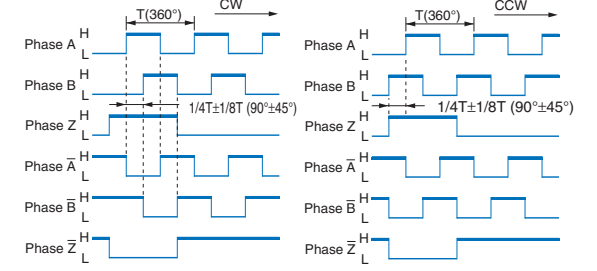
Model/Output Circuits	Output mode	Connection																		
<p>E6H-CWZ6C</p> 	<p>Open-collector output</p> <p>Direction of rotation: CW (as viewed from end of shaft) Direction of rotation: CCW (as viewed from end of shaft)</p>  <p>Note: Phase A is $1/4 T \pm 1/8 T$ faster than phase B. Note: Phase A is $1/4 T \pm 1/8 T$ slower than phase B.</p> <p>(The ONs in the above timing chart mean that the output transistor is ON and the OFFs mean that the output transistor is OFF.)</p>	<table border="1"> <thead> <tr> <th>Color</th> <th>Terminal</th> </tr> </thead> <tbody> <tr> <td>Brown</td> <td>Power supply (+Vcc)</td> </tr> <tr> <td>Black</td> <td>Output phase A</td> </tr> <tr> <td>White</td> <td>Output phase B</td> </tr> <tr> <td>Orange</td> <td>Output phase Z</td> </tr> <tr> <td>Blue</td> <td>0 V (common)</td> </tr> </tbody> </table>	Color	Terminal	Brown	Power supply (+Vcc)	Black	Output phase A	White	Output phase B	Orange	Output phase Z	Blue	0 V (common)						
Color	Terminal																			
Brown	Power supply (+Vcc)																			
Black	Output phase A																			
White	Output phase B																			
Orange	Output phase Z																			
Blue	0 V (common)																			
<p>E6H-CWZ3E</p> 	<p>Voltage output</p> <p>Direction of rotation: CW (as viewed from end of shaft) Direction of rotation: CCW (as viewed from end of shaft)</p>  <p>Note: Phase A is $1/4 T \pm 1/8 T$ faster than phase B. Note: Phase A is $1/4 T \pm 1/8 T$ slower than phase B.</p> <p>(“H” and “L” in the diagrams are the output voltage levels of phases A, B, and Z.)</p>	<table border="1"> <thead> <tr> <th>Color</th> <th>Terminal</th> </tr> </thead> <tbody> <tr> <td>Black</td> <td>Output phase A</td> </tr> <tr> <td>White</td> <td>Output phase B</td> </tr> <tr> <td>Orange</td> <td>Output phase Z</td> </tr> <tr> <td>Blue</td> <td>0 V (common)</td> </tr> </tbody> </table>	Color	Terminal	Black	Output phase A	White	Output phase B	Orange	Output phase Z	Blue	0 V (common)								
Color	Terminal																			
Black	Output phase A																			
White	Output phase B																			
Orange	Output phase Z																			
Blue	0 V (common)																			
<p>E6H-CWZ3X</p> 	<p>Line-driver output</p> <p>Direction of rotation: CW (as viewed from end of shaft) Direction of rotation: CCW (as viewed from end of shaft)</p>  <p>Note: Phase A is $1/4 T \pm 1/8 T$ faster than phase B. Note: Phase A is $1/4 T \pm 1/8 T$ slower than phase B.</p> <p>(“H” and “L” in the diagrams are the output voltage levels of phases A, B, and Z.)</p>	<table border="1"> <thead> <tr> <th>Color</th> <th>Terminal</th> </tr> </thead> <tbody> <tr> <td>Brown</td> <td>Power supply (+Vcc)</td> </tr> <tr> <td>Black</td> <td>Output phase A</td> </tr> <tr> <td>Black/red</td> <td>Output phase \bar{A}</td> </tr> <tr> <td>White</td> <td>Output phase B</td> </tr> <tr> <td>White/red</td> <td>Output phase \bar{B}</td> </tr> <tr> <td>Orange</td> <td>Output phase Z</td> </tr> <tr> <td>Orange/red</td> <td>Output phase \bar{Z}</td> </tr> <tr> <td>Blue</td> <td>0 V (common)</td> </tr> </tbody> </table> <p>Note: 1. Receiver: AM26LS32 equivalent 2. "Black/red" indicates a red strip.</p>	Color	Terminal	Brown	Power supply (+Vcc)	Black	Output phase A	Black/red	Output phase \bar{A}	White	Output phase B	White/red	Output phase \bar{B}	Orange	Output phase Z	Orange/red	Output phase \bar{Z}	Blue	0 V (common)
Color	Terminal																			
Brown	Power supply (+Vcc)																			
Black	Output phase A																			
Black/red	Output phase \bar{A}																			
White	Output phase B																			
White/red	Output phase \bar{B}																			
Orange	Output phase Z																			
Orange/red	Output phase \bar{Z}																			
Blue	0 V (common)																			

Note: Normally connect GND to 0 V or to an external ground.

Safety Precautions

Refer to *Warranty and Limitations of Liability*.

⚠ WARNING

This product is not designed or rated for ensuring safety of persons either directly or indirectly. Do not use it for such purposes.



Precautions for Correct Use

Do not use the Encoder under ambient conditions that exceed the ratings.

● **Mounting**

- The diameter of the mating shaft must be $8_{-0.004}^{-0.012}$ mm and 8 to 11 mm long from the mounting surface.
- The allowable displacement in the mating shaft must 0.05 mm in the radial direction and 0.3 mm in the thrust direction.
- The mounting surface and shaft must be perpendicular to within 0.03 mm.
- When securing the Encoder, do not allow force to be applied to the leaf spring (*).

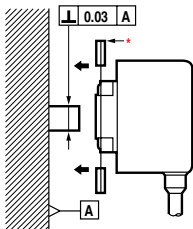

Eccentricity will develop in the Encoder if the above values are not satisfied, and the mounting leaf spring may be destroyed.

- When securing the Encoder, use two M3 screws to secure the leaf spring to the mounting surface.
- Use the Allen set screw provided with the hollow shaft to secure the shaft. Use a tightening torque of 0.4 N·m and apply screw lock glue to the screw to prevent it from becoming loose.
- If wiring after securing the Encoder, do not pull on the cable. Also, do not apply shock to the Encoder or hollow shaft.
- If the Encoder phase Z must be aligned with the origin of the installation device, mount the Encoder while checking the phase Z output.

● **Wiring**

Spurious pulses may be generated when power is turned ON and OFF. Wait at least 0.1 s after turning ON the power to the Encoder before using the connected device, and stop using the connected device at least 0.1 s before turning OFF the power to the Encoder. Also, turn ON the power to the load only after turning ON the power to the Encoder.

Rotary Encoder Recommended Power Supplies: Consult your OMRON representative for details.

(Unit: mm)

Dimensions

Tolerance class IT16 applies to dimensions in this datasheet unless otherwise specified.

E6H-C

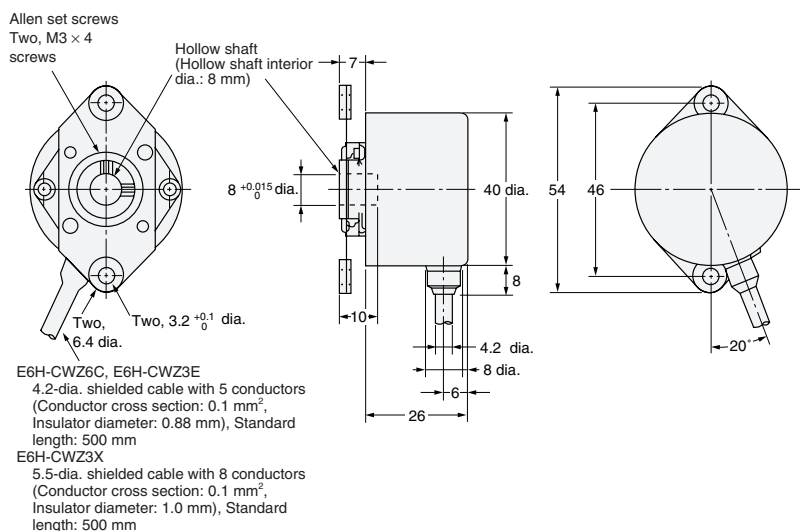
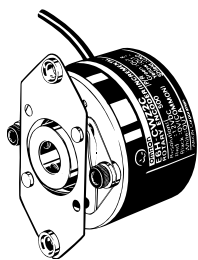

Terms and Conditions Agreement

Read and understand this catalog.

Please read and understand this catalog before purchasing the products. Please consult your OMRON representative if you have any questions or comments.

Warranties.

(a) Exclusive Warranty. Omron's exclusive warranty is that the Products will be free from defects in materials and workmanship for a period of twelve months from the date of sale by Omron (or such other period expressed in writing by Omron). Omron disclaims all other warranties, express or implied.

(b) Limitations. OMRON MAKES NO WARRANTY OR REPRESENTATION, EXPRESS OR IMPLIED, ABOUT NON-INFRINGEMENT, MERCHANTABILITY OR FITNESS FOR A PARTICULAR PURPOSE OF THE PRODUCTS. BUYER ACKNOWLEDGES THAT IT ALONE HAS DETERMINED THAT THE PRODUCTS WILL SUITABLY MEET THE REQUIREMENTS OF THEIR INTENDED USE.

Omron further disclaims all warranties and responsibility of any type for claims or expenses based on infringement by the Products or otherwise of any intellectual property right. (c) Buyer Remedy. Omron's sole obligation hereunder shall be, at Omron's election, to (i) replace (in the form originally shipped with Buyer responsible for labor charges for removal or replacement thereof) the non-complying Product, (ii) repair the non-complying Product, or (iii) repay or credit Buyer an amount equal to the purchase price of the non-complying Product; provided that in no event shall Omron be responsible for warranty, repair, indemnity or any other claims or expenses regarding the Products unless Omron's analysis confirms that the Products were properly handled, stored, installed and maintained and not subject to contamination, abuse, misuse or inappropriate modification. Return of any Products by Buyer must be approved in writing by Omron before shipment. Omron Companies shall not be liable for the suitability or unsuitability or the results from the use of Products in combination with any electrical or electronic components, circuits, system assemblies or any other materials or substances or environments. Any advice, recommendations or information given orally or in writing, are not to be construed as an amendment or addition to the above warranty.

See <http://www.omron.com/global/> or contact your Omron representative for published information.

Limitation on Liability; Etc.

OMRON COMPANIES SHALL NOT BE LIABLE FOR SPECIAL, INDIRECT, INCIDENTAL, OR CONSEQUENTIAL DAMAGES, LOSS OF PROFITS OR PRODUCTION OR COMMERCIAL LOSS IN ANY WAY CONNECTED WITH THE PRODUCTS, WHETHER SUCH CLAIM IS BASED IN CONTRACT, WARRANTY, NEGLIGENCE OR STRICT LIABILITY.

Further, in no event shall liability of Omron Companies exceed the individual price of the Product on which liability is asserted.

Suitability of Use.

Omron Companies shall not be responsible for conformity with any standards, codes or regulations which apply to the combination of the Product in the Buyer's application or use of the Product. At Buyer's request, Omron will provide applicable third party certification documents identifying ratings and limitations of use which apply to the Product. This information by itself is not sufficient for a complete determination of the suitability of the Product in combination with the end product, machine, system, or other application or use. Buyer shall be solely responsible for determining appropriateness of the particular Product with respect to Buyer's application, product or system. Buyer shall take application responsibility in all cases.

NEVER USE THE PRODUCT FOR AN APPLICATION INVOLVING SERIOUS RISK TO LIFE OR PROPERTY OR IN LARGE QUANTITIES WITHOUT ENSURING THAT THE SYSTEM AS A WHOLE HAS BEEN DESIGNED TO ADDRESS THE RISKS, AND THAT THE OMRON PRODUCT(S) IS PROPERLY RATED AND INSTALLED FOR THE INTENDED USE WITHIN THE OVERALL EQUIPMENT OR SYSTEM.

Programmable Products.

Omron Companies shall not be responsible for the user's programming of a programmable Product, or any consequence thereof.

Performance Data.

Data presented in Omron Company websites, catalogs and other materials is provided as a guide for the user in determining suitability and does not constitute a warranty. It may represent the result of Omron's test conditions, and the user must correlate it to actual application requirements. Actual performance is subject to the Omron's Warranty and Limitations of Liability.

Change in Specifications.

Product specifications and accessories may be changed at any time based on improvements and other reasons. It is our practice to change part numbers when published ratings or features are changed, or when significant construction changes are made. However, some specifications of the Product may be changed without any notice. When in doubt, special part numbers may be assigned to fix or establish key specifications for your application. Please consult with your Omron's representative at any time to confirm actual specifications of purchased Product.

Errors and Omissions.

Information presented by Omron Companies has been checked and is believed to be accurate; however, no responsibility is assumed for clerical, typographical or proofreading errors or omissions.